

# SASH HARDWARE

**TA-3960F-PWS (BRASSED)  
TA-3960GV-PWS (ZINC)**  
HOLD TITE ADJUSTABLE SASH LOCK

**SIMILAR  
HAGER  
#1484**

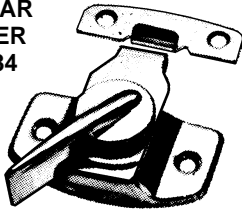

**Description:** Stamped steel, polybagged with screws.  
**Finish:** Brass and zinc plated.  
**Packing:** 25 per box  
500 per carton  
**Weight:** 4½ lbs. per box  
**List Price:**  
Brass - 1.45 each  
Zinc Plated - 1.45 each

**TA-3950F-PWS  
STAMPED STEEL SASH LOCK**

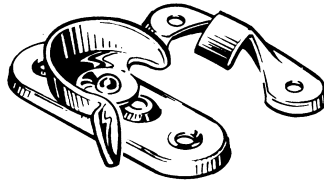

**SIMILAR HAGER #1487**

**Description:** Stamped steel, polybagged with screws.  
**Finish:** Brass plated.  
**Packing:** 25 per box  
1000 per carton  
**Weight:** 2½ lbs. per box  
**List Price:** .85 each

**TA-3955  
SASH FASTENER**

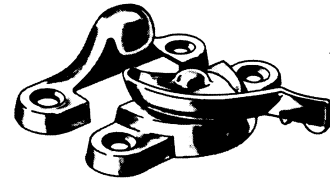

**SIMILAR STANLEY #7073**

**Description:** Rust proof zinc alloy, available polybagged with screws (PWS).

**Packing:** 25 per box  
500 per carton

**Weight:** 2¾ lbs. per box

Finish	Symbol	List Price
Brass	F	\$1.00
Bronze	BZ	1.00
Unichrome	ZN	1.00
Antique Brass	AB	1.05

PLEASE USE "FINISH" SYMBOL AFTER PART NUMBER

**TA3980 PWS  
STREAMLINE SASH LIFT**

**SUPER  
BARGAIN  
PRICE**



**SIMILAR  
HAGER #1483**

**Description:** Modern styling—wrought steel base size 4" x 1½", projection 15/16", poly bag with screws.  
**Packing:** 20 pcs. per box  
600 pcs. per ctn  
**Weight:** 8 lbs. per 100 pcs.

Finish	Symbol	List Price
Brass	F	\$.68 ea.
Bronze	BZ	.68 ea.
Antique Brass	AB	.68 ea.

**TA3985 PWS  
BAR SASH LIFT**



**SIMILAR STANLEY #7074**

**Description:** Rust proof zinc alloy; size 4", projection 7/8" poly bag with screws.  
**Packing:** 25 pcs. per box  
500 pcs. per ctn.  
**Weight:** 13 lbs. per 150 pcs.

Finish	Symbol	List Price
Brass	F	\$.60 ea.
Bronze	BZ	.63 ea.
Antique Brass	AB	.63 ea.

**TA-3975F-PWS  
STAMPED STEEL HOOK SASH LIFTS**

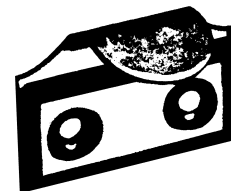

**SIMILAR STANLEY #486**

**2 Poly Bagged with screws**

**Description:** Stamped Steel hook sash lifts with screws.  
**Finish:** Brass Plated  
**Packing:** 25 bags of 2 per box  
500 bags of 2 per case  
**Weight:** 1½ lbs. per box  
**List Price:** .80 per bag of 2

M

# CAFE DOOR GRAVITY PIVOT HINGE SETS



**AVAILABLE CARDED  
OR POLYBAGGED  
WITH HEADER**

**10 Sets per box  
120 Sets per case  
6 lbs. per box**

- Hinge can adjust to align doors.
- For carefree performance of louver or small doors 3/4" to 1 3/8" thick.
- These hinges hold door open at 90° on either side of opening
- Gravity returns door to center position automatically
- Door weight carried on tough, silent nylon bearings

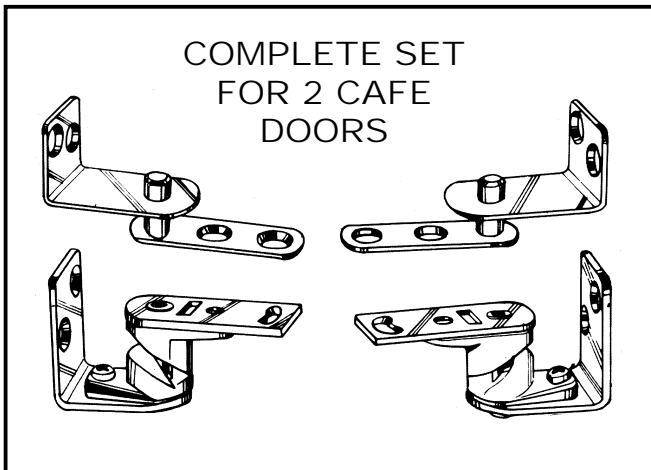

ITEM NO.	WT./SETS	LIST PRICE
TA-3500F-PWS	6 lbs./10	\$4.73 bag.
CD-3500F-WS	6 1/2 lbs./10	\$5.13 cd.

## TA-3540F-PWS & CD-3540F-WS 4 PANEL SHUTTER HARDWARE SETS

### WRAP-AROUND HINGE

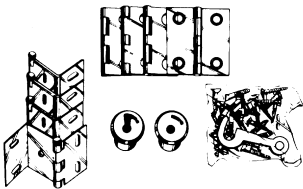

**Description:** 4 mounting hinges, 4 inner panel hinges, 36 hinge screws, 1 catch with screws and washers, 2 porcelain knobs with screws—individually poly-bagged with header or individually carded.



**Available Carded  
or Polybagged  
with Header**

ITEM NO.	PER CASE	WT./SETS	LIST PRICE
TA-3540F-PWS	120 SETS	5 LBS/10	\$4.18 ea.
CD-3540F-WS	120 SETS	5 1/2 LBS/10	\$4.70 cd.

## KNIFE-TYPE RIVETTED PIN INVISIBLE CABINET HINGE

### OLD COPPER FINISH

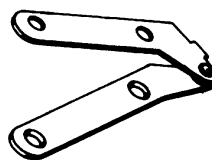

**PLEASE SPECIFY  
RIGHT OR LEFT HANDED**

Hinges are very tight pin type which avoids need of a friction or magnetic catch. Door will stay in closed position.

**List Price: \$.23 each**

## TA-2990-PWS 3" TOUCH LATCH

### UNICHROME PLATED

Polybagged  
with screws

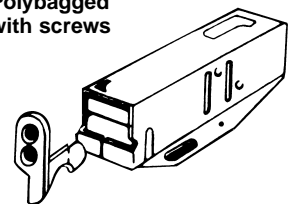

- Keeps doors closed
- Springs open at a touch
- Eliminates the need for a handle
- Completely concealed
- Great when hands are full – Can be opened or closed with a finger, elbow, wrist or knee.

**Weight:** 8 lbs.

**Packed:** 50/box

**List Price: \$1.65 each**

# MAGNETIC, FRICTION & BALL CATCHES & ROLLER LATCHES

**TA2900-PWS**

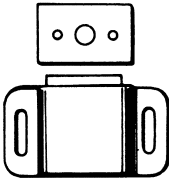

White Plastic Cased

**Weight:** 4¼ lbs./100 pcs.

**Packing:** 25 per box —  
1000 per case  
with screws

**List Price:** \$.43 each

**TA2920-PWS**

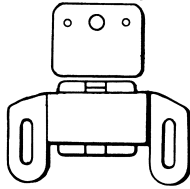

Tan Plastic Cased

**Weight:** 6½ lbs./100 pcs.

**Packing:** 25 per box —  
1000 per case  
with screws

**List Price:** \$.53 each

**TA2930-PWS**

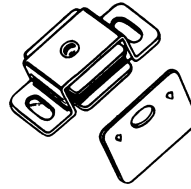

Solid Aluminum Cased

**Weight:** 4¾ lbs./100 pcs.

**Packing:** 25 per box —  
1000 per case  
with screws

**List Price:** \$.80 each

**TA2960-PWS**

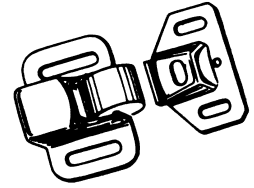

Single Rubber Roller

**Weight:** 4½ lbs./100 pcs.

**Packing:** 50 per box —  
1000 per case  
with screws

**List Price:** \$.55 each

**TA2970-PWS**

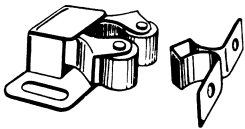

Double Nylon Roller

**Weight:** 4¾ lbs./100 pcs.

**Packing:** 50 per box —  
1000 per case  
with screws

**List Price:** \$.33 each

**TA2950-PWS**

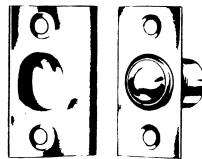

**Packing:** 12 per box  
(polybagged w/screws)  
120 per case  
6 per box; 60 per case  
(carded)

**List Price:** \$2.50 each

**TA2955-PWS**

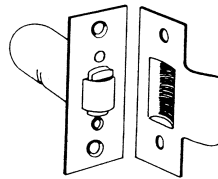

**Packing:** 12 per box  
(polybagged w/screws)  
120 per case  
6 per box; 60 per case  
(carded)

**List Price:** \$2.50 each

**TA2925-PWS**

"Amerock Type" Magnetic Catch

Similar to  
Amerock  
#9765

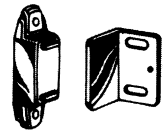

**Description:** Powerful magnetic  
catch complete with strike &  
screws with floating action holds  
cabinet door securely.

**Finish:** Tan Color

**Packing:** 25 per box — 500 per  
case poly bagged with screws

**List Price:** \$.80 each

## MODEL DX-HD2935 PWS HEAVY DUTY TRIPLE MAGNETIC CATCH

- Triple self aligning magnets provide extra holding power
- Solid Aluminum housing
- Elongated screw holes for easy adjustment
- Designed for heavier cabinet doors
- Can be used for double door installations
- Has holding power up to 35 lbs.
- Furnished individually polybagged with screws
- Packed 25 per box; 250 per master carton

**\$1.98 Each**

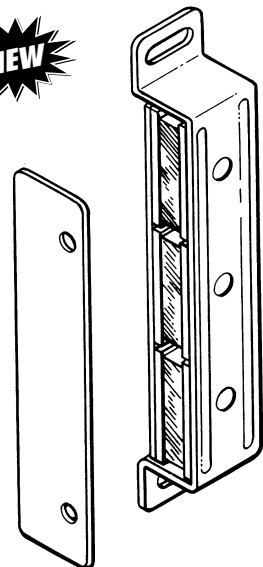

M

# NO-MORTISE TYPE & BI-FOLDING DOOR HINGES

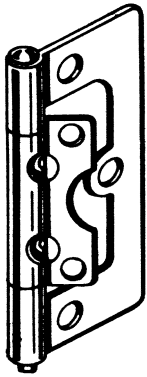

NO-MORTISE TYPE					
DESCRIPTION	ITEM NO. & FINISH	SIZE	PR./CASE	WT. PER DOZ. PR.	LIST PRICE PER PAIR
<b>NO-MORTISE TYPE HINGES</b> Steel, loose pin, poly bagged with screws, boxed per dozen pair	TA3000F-PWS Brass Plated	2"	50 Doz. Pr.	1 lb.	<b>\$.95/Pr</b>
		2½"	50 Doz. Pr.	1¼ lbs.	<b>1.23</b>
		3"	40 Doz. Pr.	3 lbs.	<b>1.75</b>
		3½"	25 Doz. Pr.	5.25 lbs.	<b>2.70</b>
		4"	25 Doz. Pr.	5.8 lbs.	<b>3.40</b>
<b>NO-MORTISE TYPE HINGES</b> Steel, loose pin, carded with screws, boxed 12 cards	CD3000F Brass Plated 2 Hinges/Card	2½"	120 Cards	1¼ lbs.	<b>\$2.05/Cd</b>
		3"	120 Cards	3 lbs.	<b>2.70</b>
		3½"	120 Cards	5.25 lbs.	<b>4.08</b>
		4"	60 Cards	5.8 lbs.	<b>4.38</b>

## 2 & 3 FLAP BI-FOLDING DOOR HINGES

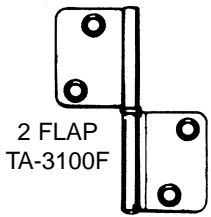

2 FLAP  
TA-3100F

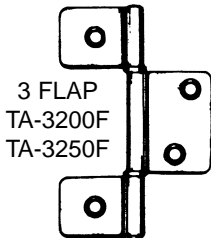

3 FLAP  
TA-3200F  
TA-3250F

3 FLAP  
CD-3250F

DESCRIPTION	ITEM NO. & FINISH	SIZE	PR./CASE	WT. PER CARTON	LIST PRICE PER HINGE
<b>2-FLAP, NYLON BEARING BI-FOLDING DOOR HINGES,</b> Non-mortising type, with or without screws	TA-3100F	3 x 1½"	50 hinges per carton 1000 hinges per case	4.7 lbs./ctn.	<b>\$.50</b>
TA3100F is a handed hinge. Please order RH or LH as required.					
<b>3-FLAP, NYLON BEARING BI-FOLDING DOOR HINGES,</b> Non-mortising type, with or without screws	TA-3200F	3 x 1½"	200 hinges per carton 1200 hinges per case	16 lbs./ctn.	<b>\$.50</b>
	TA-3250F	3⅞" x 1¼"		18 lbs./ctn.	<b>\$.50</b>
TA3100F, TA3200F and TA3250F -- Add \$.015 per hinge if required with ¾" brass plated Phillips head screws.					
<b>3-FLAP, NYLON BEARING BI-FOLDING DOOR HINGES,</b> Non-mortising type, with or without screws	CD-3250F 2 Hinges/Card	3⅞" x 1¼"	120 cards per carton	3 lbs.	<b>\$ 1.73/Cd</b>

# 5/16" Diameter • Solid Brass or Aluminum ARCHITECTURAL PULLS

- Projection 1 5/16"
- Diameter 5/16"
- Fasteners  
Standard Size (packed with all architectural pulls)  
2-1" x 8-32 machine screws  
For thicker doors up to 1 3/8", specify 2-1 5/8" x 8-32 machine screws

- Item No. (Brass)  
3" – SB4483  
3 1/2" – SB44835  
4" – SB4484

- Item No. (Alum)  
3" – AL4483A  
3 1/2" – AL44835A  
4" – AL4484A

• Finishes (5)

US3	Polished Brass	PB
US4	Satin Brass	SB
US5	Antique Brass	AB
US26	Polished Chrome	CMP
US26D	Satin Chrome	CMD
US28	Satin Aluminum	ALU

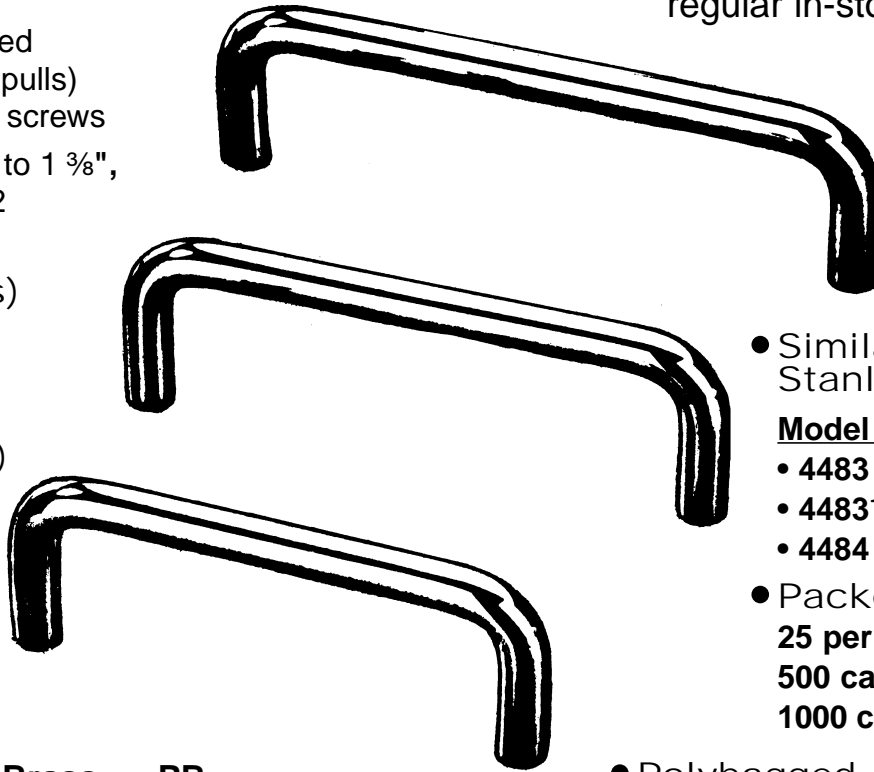

**Note:**

We can also supply 5" and 6" sizes although they are not regular in-stock items.

- Similar to Stanley

**Model No:**

- 4483
- 4483 1/2
- 4484
- Packed  
25 per box  
500 carton (3")  
1000 carton (3 1/2"- 4")

- Polybagged with machine screws
- For cabinet doors or drawers 3/4" through 1 3/8" in thickness
- Made of Solid Wrought Brass or Aluminum

*"The most popular type of pulls used by the trade"*

NET PRICE EACH POLYBAGGED WITH MACHINE SCREWS					
3" SB4483 (all finishes)	3" AL4483	3 1/2" SB44835 (all finishes)	3 1/2" AL44835	4" SB4484 (all finishes)	4" AL4484
List Price \$1.93 each	List Price \$1.03 each	List Price \$2.08 each	List Price \$1.18 each	List Price \$2.20 each	List Price \$1.33 each
<b>REDUCED!</b>		<b>REDUCED!</b>		<b>REDUCED!</b>	





# OUR NEW WEB SITE IS LIVE!

FOR INSTANT ACCESS TO OUR ONLINE CATALOG & PROMOTIONS, VISIT OUR WEB SITE TODAY:

[www.transatlanticco.com](http://www.transatlanticco.com)

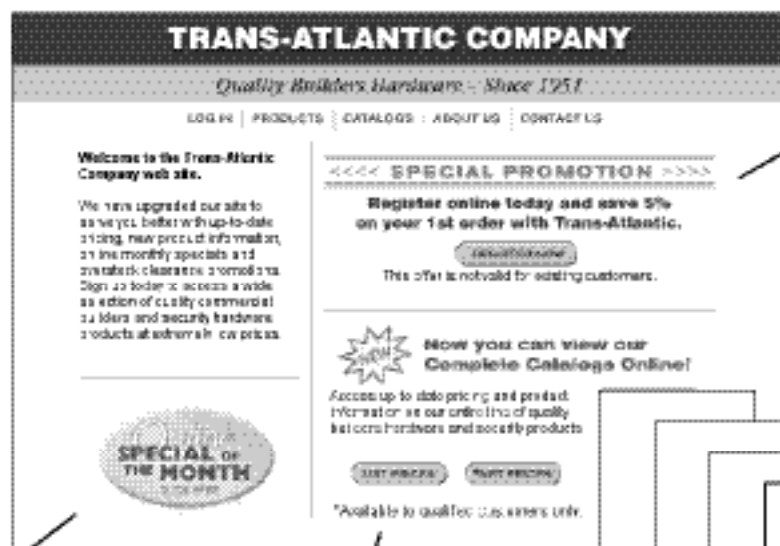

## NEW PRODUCTS

Added often to our regular product line.

## MONTHLY SPECIALS

Closeouts, special lots and incentives.

## CURRENT PRICING

List prices for our full product line.

## ONLINE REQUESTS

Order free copies of our printed catalogs and recent promotions.

