

LIGHT TEE & STRAP HINGES

Light Tee Hinges, Plain Steel Finish

	Description	Size	Item No.	Pr/Case	Wt./Box	List Price Per Dz. Pr.	List Price Per Pair
	Light Tee Hinges (Similar Stanley 904K) (zinc plated) boxed per doz. pr. without screws.	2" 3" 4" 5" 6" 8"	TA300GV	25 doz. 25 doz. 25 doz. 20 doz. 10 doz. 10 doz.	1.8 3.0 3.5 4.5 5.5 7.5	\$9.88 13.65 15.63 20.35 23.38 44.00	\$.83 1.15 1.30 1.70 1.95 3.67
Light Tee Hinges Electro zinc plated brass pin. Individually boxed per pair with screws. (Similar Stanley SC904RBP)	2" 3" 4" 5" 6" 8"	TA300HGV-BP	100 pr. 100 pr. 100 pr. 100 pr. 100 pr. 100 pr.	.20 .30 .30 .40 .50 .60		\$3.28 3.53 4.10 5.10 7.15 11.38	

Light Strap Hinges, Plain Steel Finish

	Description	Size	Item no.	Pr/Case	Wt./Box	List Price Per Dz. Pr.	List Price Per Pair
	Light Strap Hinges (Similar Stanley 900K) (zinc plated) boxed per doz. pr. without screws.	2" 3" 4" 5" 6" 8"	TA400GV	25 doz. 25 doz. 25 doz. 10 doz. 10 doz. 10 doz.	1.8 2.5 3.5 5.3 7.0 11.6	\$11.18 12.75 15.90 21.25 24.83 57.50	.93 1.08 1.33 1.78 2.08 4.89
Light Strap Hinges Electro zinc plated brass pins. Individually boxed per pair with screws. (Similar to Stanley SC900RBP)	2" 3" 4" 5" 6" 8"	TA400HGV-BP	100 pr. 100 pr. 100 pr. 100 pr. 100 pr. 100 pr.	.20 .20 .30 .40 .60 1.00		3.25 3.38 4.10 5.78 6.83 12.00	

EXTRA HEAVY TEE AND STRAP HINGES

FULL USA HEAVY GAUGE & SIZES LIKE STANLEY 902-908 SERIES

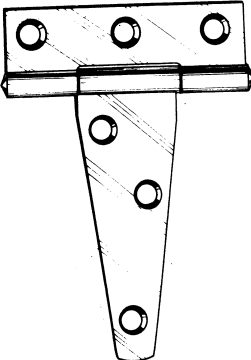
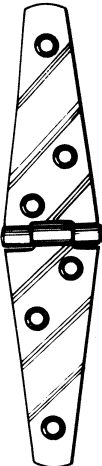
	Description	Size	Item No.	Pair per case	Wt. Per dozen pair (lbs.)	List Price per dozen pair	List Price per pair		
	TA-1800 — EXTRA HEAVY TEE HINGES in Plain Steel, Zinc Plated, and Electro Zinc Plated with Brass Pin and Screws								
	NO. TA-1800PS EX. HY TEE HINGES, plain steel without screws Similar Stanley 908	4" 5" 6" 8" 10"	TA-1800PS	10 doz. 5 doz. 4 doz. 2 doz. 1 doz.	8.0 14 21 37 57	\$31.00 49.38 73.33 119.88 183.38	\$ 2.58 4.13 6.10 10.00 15.28		
	NO. TA-1800GV EX. HY TEE HINGES zinc plated without screws Similar Stanley 908K	4" 5" 6" 8" 10"	TA-1800GV	10 doz. 5 doz. 4 doz. 2 doz. 1 doz.	8.0 14 21 37 57	\$32.75 55.88 76.90 120.68 197.03	\$2.73 4.66 6.41 10.06 16.43		
	NO. TA-1800HGV-BP EX. HY TEE HINGES electro zinc plated with brass pin & screws Similar Stanley SC908RBP	4" 5" 6" 8" 10"	TA-1800HGV-BP	100 pr. 50 pr. 50 pr. 25 pr. 20 pr.	0.8 1.1 1.9 3.3 5.1		\$8.33 11.45 13.38 20.75 32.38		
	TA-1900 — HEAVY STRAP HINGES in Plain Steel, Zinc Plated, and Electro Zinc Plated with Brass Pin and Screws								
		NO. TA-1900PS HEAVY STRAP HINGES, plain steel without screws Similar Stanley 902	4" 5" 6" 8" 10"	TA-1900PS	10 doz. 5 doz. 4 doz. 2 doz. 1 doz.	6.0 10 18 34 51	\$31.38 42.85 71.55 115.18 164.25	\$ 2.61 3.57 5.98 9.60 13.69	
		NO. TA-1900GV HEAVY STRAP HINGES zinc plated without screws Similar Stanley 902K	4" 5" 6" 8" 10"	TA-1900GV	10 doz. 5 doz. 4 doz. 2 doz. 1 doz.	6.0 10 18 34 51	\$33.98 48.05 76.43 120.85 171.40	\$2.83 4.00 6.37 10.07 14.28	
		NO. TA-1900HGV-BP HEAVY STRAP HINGES electro zinc plated with brass pin & screws Similar Stanley SC1902RBP	4" 5" 6" 8" 10"	TA-1900HGV-BP	100 pr. 50 pr. 50 pr. 25 pr. 20 pr.	0.6 1.0 1.7 3.1 4.6		\$5.65 9.00 10.60 16.40 29.73	
		<p>1) 6", 8" TA-1800 & TA-1900PS & GV packed ¼ dozen pair per box, 10" packed 1 dozen pair in compact wooden case 4", 5", ½ doz. pr. per box.</p> <p>2) Electro zinc plated strap hinges with brass pins and screws are individually boxed per pair.</p> <p>3) TA-1800 & TA-1900PS & GV priced per dozen pair; TA-1800 & TA-1900HGV-BP priced per pair.</p>							

**ONLY IMPORTED EXTRA HEAVY TEE & STRAP HINGES
SAME FULL HEAVY GAUGE AS USA MADE**

BROAD BUTTS

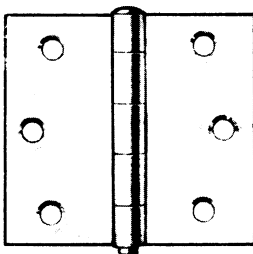
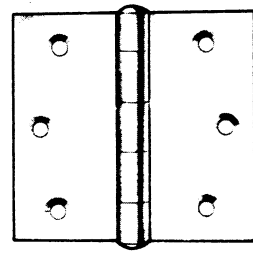
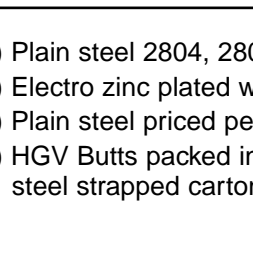
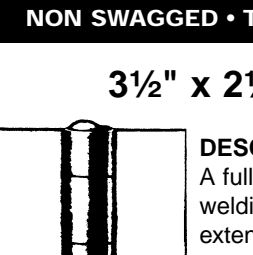
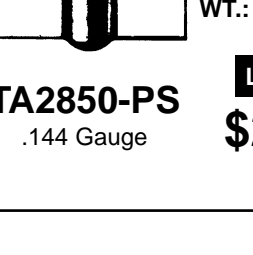
	Description	Size	Item No.	Per Case	Wt. Per Unit/Dz.	List Price Per Dz. Pr.	List Price Per Pr.
 <p>LOOSE PIN</p>	BROAD FULL MORTISE, loose pin, without screws, plain steel, (Similar Stanley 804)	2 x 2	TA-2804PS	25 doz. pr.	2.8	\$22.70	\$1.89
		2½ x 2½		20 doz. pr.	4.3	28.05	2.34
		3 x 3		12 doz. pr.	6.0	33.40	2.78
		3½ x 3½		5 doz. pr.	12	39.08	3.26
		4 x 4		5 doz. pr.	17	47.25	3.94
 <p>LOOSE PIN</p>	BROAD FULL MORTISE, loose pin, electro zinc plated with brass pins & screws (Similar Stanley SC804RBP)	2 x 2	TA-2804HGV-BP	100 pr.	.30		\$ 4.70
		2½ x 2½		100 pr.	.50		6.03
		3 x 3		100 pr.	.70		7.25
		3½ x 3½		100 pr.	1.0		8.35
		4 x 4		100 pr.	1.5		10.35
 <p>LOOSE PIN</p>	BROAD FULL MORTISE, loose pin, electro zinc plated with brass pins & screws (Similar Stanley SC804RBP)	3½ x 3½	RC-2804HGV-BP (Rd. Corner)	100 pr.	1.0		\$ 8.18
		4 x 4		100 pr.	1.5		9.43
 <p>FAST SPUN PIN</p>	BROAD FULL MORTISE, tight pin, without screws, plain steel (Similar Stanley 808)	2 x 2	TA-2808PS	25 doz. pr.	2.8	\$ 22.70	\$ 1.89
		2½ x 2½		20 doz. pr.	4.3	25.53	2.13
		3 x 3		12 doz. pr.	6.0	33.40	2.78
		3½ x 3½		5 doz. pr.	12	39.08	3.26
		4 x 4		5 doz. pr.	17	47.25	3.94
 <p>FAST SPUN PIN</p>	BROAD BLANK HINGES blank, tight pin, flat back (surface welding application) hinges - Plain steel finish. (Similar to Stanley 808)	2 x 2	TA-2818NH-PS	25 doz. pr.		\$ 24.58	\$ 2.05
		2½ x 2½		20 doz. pr.		26.48	2.21
		3 x 3		12 doz. pr.		34.03	2.84
		3½ x 3½		5 doz. pr.		40.95	3.41
		4 x 4		5 doz. pr.		54.20	4.52

- 1) Plain steel 2804, 2808 and 2818 boxed 12 pr. in sizes 2 x 2, 2½ x 2½; 6 pair per box in sizes 3 x 3, 3½ x 3½, 4 x 4.
- 2) Electro zinc plated with brass pin, items 2804HGV-BP individually boxed per pair with screws.
- 3) Plain steel priced per dozen pair; plated items priced per pair.
- 4) HGV Butts packed in wooden cases containing 100 pair; inner packing 2 x 2, 2½ x 2½, 3 x 3 and 3½ x 3½ in cross steel strapped cartons of 50 pair, 4 x 4, same in 25 pair cartons.

HEAVY GAUGE • WROUGHT STEEL WELDING BUTTS

FULL SURFACE-BLANK LEAVES
NON SWAGGED • TIGHT PIN

3½" x 2¼"

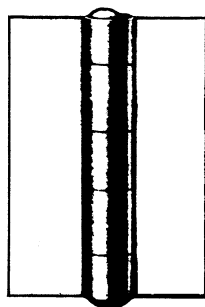

DESCRIPTION:
A full surface welding hinge used extensively on ornamental iron doors and gates.
FINISH: Plain Steel
PACKED: 10 pr./box
WT.: 6 lbs.

TA2850-PS
.144 Gauge

LIST PRICE
\$2.50 pair

EXTRA HEAVY DUTY WROUGHT STEEL WELDING BUTTS

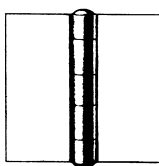

TA2850 PS

Full Service
Blank Leaves
Non-Swagged Tight Pin
Fast spun pin

Size	Gauge Thickness	Pairs per box	Pairs per master case	List Price
2 x 2	.106	5	100	\$4.03pr
2½ x 2½	.118	5	100	7.18
3 x 3	.128	1	30	9.25
3½ x 3½	.144	1	25	13.93
4 x 4	.161	1	20	18.08
4½ x 4½	.161	1	20	22.90
5 x 5	.186	1	20	34.45
6 x 6	.206	1	10	52.80

PLAIN STEEL • LOOSE PIN FULL MORTISE HINGE

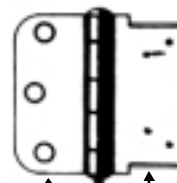

↑ This leaf full mortise application on door.
↑ This leaf slotted application on metal frame.

AW35PS

3½" x 3½"

One leaf square corner,
One leaf with ⅝" radius round corner

For use with metal frames and wood doors

Hinges Handed

If no handing specified on your order we will ship
½ RH - ½ LH

\$3.55 Per Pair

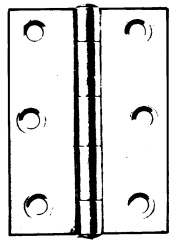
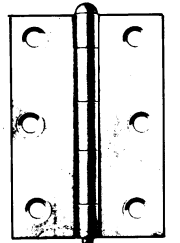
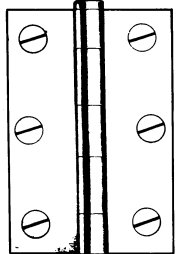
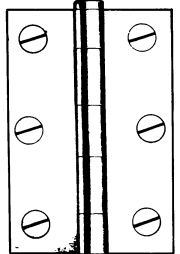

50/Case - \$1.35/pr.

LIGHT NARROW CABINET HINGES & BACK FLAPS

	Description	Finish	Item No.	Size	Pair per case	Wt. per doz. pr. (lbs.)	List Price per doz. pr.	List Price per pair
TA-2814 BACK FLAP HINGES Steel, tight pin, without screws								
 <p>FAST SPUN PIN</p>	Back Flaps tight pin Similar Stanley 814	Plain Steel	TA-2814PS	1"	50 doz.	1.3	\$13.15	\$1.10
				1½"	25 doz.	2.0	15.65	1.30
				1½"	25 doz.	2.5	20.38	1.70
				2"	25 doz.	5.0	27.73	2.31
TA-2838 LIGHT NARROW BUTTS Steel, tight pin, without screws								
 <p>FAST SPUN PIN</p>	Light Narrow Butts tight pin Similar Stanley 838	Plain Steel	TA-2838PS	1"	50 doz.	0.5	\$6.73	\$.56
				1½"	50 doz.	1.0	8.05	.67
				2"	50 doz.	1.5	9.78	.81
				2½"	25 doz.	2.3	12.30	1.03
				3"	25 doz.	3.5	17.33	1.44
	Light Narrow Butts tight pin Similar Stanley 838	Brass Plated	TA-2838F	1"	50 doz.	0.5	\$8.33	\$.69
				1½"	50 doz.	1.0	9.33	.78
				2"	50 doz.	1.5	10.30	.86
				2½"	25 doz.	2.3	12.93	1.08
				3"	25 doz.	3.5	20.48	1.70
	Light Narrow Butts tight pin Similar Stanley 838	Zinc Plated	TA-2838GV	1"	50 doz.	0.5	\$7.38	\$.61
				1½"	50 doz.	1.0	8.55	.71
2"				50 doz.	1.5	10.10	.84	
2½"				25 doz.	2.3	11.68	.97	
3"				25 doz.	3.5	17.03	1.42	
TA-2840 LIGHT NARROW BUTTS Steel, loose pin, without screws								
 <p>LOOSE PIN</p>  <p>NARROW LOOSE PIN</p>	Light Narrow Butts loose pin Similar Stanley 840	Plain Steel	TA-2840PS	1"	50 doz.	0.5	\$6.73	\$.56
				1½"	50 doz.	1.0	8.05	.67
				2"	50 doz.	1.5	9.20	.77
				2½"	25 doz.	2.3	10.93	.91
				3"	25 doz.	3.5	16.03	1.34
	Light Narrow Butts loose pin Similar Stanley 840	Brass Plated	TA-2840F	1"	50 doz.	0.5	\$8.33	\$.69
				1½"	50 doz.	1.0	9.33	.78
				2"	50 doz.	1.5	10.30	.86
				2½"	25 doz.	2.3	12.63	1.05
				3"	25 doz.	3.5	18.88	1.57
	Light Narrow Butts loose pin Similar Stanley 840	Zinc Plated	TA-2840GV	1"	50 doz.	0.5	\$7.38	\$.61
				1½"	50 doz.	1.0	8.55	.71
2"				50 doz.	1.5	10.25	.85	
2½"				25 doz.	2.3	11.58	.96	
3"				25 doz.	3.5	16.68	1.39	
TA-2981, TA-2982 LIGHT NARROW CABINET HINGES loose pin, with screws (Button or Ball tip)								
 <p>NARROW LOOSE PIN</p>	Light Narrow Butts with screws (ball or button tip) Similar Stanley 295	Brass Plated and Dull Nickel	TA-2981F (Ball Tip) TA-2982F (Button Tip) All sizes available in both types	1" x 1"	50 doz.	0.4	\$15.23	\$1.27
				1½" x 1¼"	50 doz.	0.8	16.60	1.38
				2" x 1⅝"	50 doz.	1.4	18.75	1.56
				2½" x 1⅝"	25 doz.	1.8	19.68	1.66
				3" x 1⅝"	25 doz.	2.6	23.63	1.97
ALSO AVAILABLE IN DULL NICKEL FINISH 2981-2982DN-PWS								

SAFETY AND HINGE HASPS

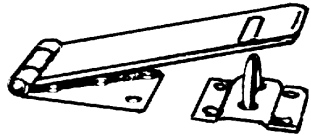
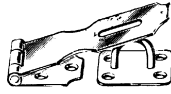
NEW WIDER ASSORTMENT INCLUDING SWIVEL TYPE, KEY LOCKING TYPE AND EXTRA HEAVY DUTY TYPES

	Description	Size	Item No.	Wt. per doz. (lbs.)	Per case	List Price per doz.	List Price each		
TA-500 SAFETY HASPS with adjustable staples, boxed & priced per dozen without screws. 	Similar Stanley 915 (plain steel) without screws	3" 3½" 4½" 6"	TA-500PS	2.75 3.00 3.75 8.00	25 doz. 25 doz. 25 doz. 12 doz.	\$10.33 10.65 13.05 25.18	\$.86 .88 1.09 1.87		
	Similar Stanley 915K (zinc plated) without screws	3" 3½" 4½" 6"	TA-500GV	2.75 3.00 3.75 8.00	25 doz. 25 doz. 25 doz. 12 doz.	\$11.53 13.40 15.75 28.83	\$.96 1.12 1.31 2.40		
	Hot dipped galv. brass pin individually boxed with screws. Similar Stanley SC915 RBP	3" 3½" 4½" 6"	TA-500HGV-BP	0.23 0.25 0.31 0.67	100 ea. 100 ea. 100 ea. 100 ea.		\$3.65 3.75 4.70 7.28		
	TA-500L LIGHT SAFETY HASPS  with fixed staples, boxed per doz. without screws.	Similar Stanley 911 (plain steel or zinc plated) without screws	2" 2½" 2" 2½"	TA-500L-PS TA-500L-GV	0.65 0.84 0.65 0.84	50 doz. 50 doz. 50 doz. 50 doz.	\$5.85 6.83 6.83 8.55	\$.49 .57 .57 .71	
		TA-600 HINGE HASPS boxed per dozen without screws. 	Similar Stanley 912 (plain steel) without screws	3" 4½" 6"	TA-600PS	1.75 2.50 5.00	25 doz. 20 doz. 12 doz.	\$9.58 14.18 22.40	\$.80 1.18 1.87
			Similar Stanley 912K (zinc plated) without screws	3" 4½" 6"	PA-600GV	1.75 2.50 5.00	25 doz. 25 doz. 12 doz.	\$10.13 16.40 23.20	\$.84 1.37 1.93
			Staples Only without screws (plain steel)	2-2½" 3½"-4" 6"					\$3.03 4.28 6.68

TA-600X-GV-PWS GARAGE AND UTILITY DOOR EXTRA-HEAVY HINGE HASPS



SIZE: 7½"
PACKED: 6/CTN - 60/CASE (poly bagged)
WEIGHT: 12 LBS/DZ
FINISH: UNICHROME PLATED
LIST PRICE: 5.13 EA.

CD-575Z SINGLE FLEXIBLE LINK SAFETY HASP



SIZE: 6¼", ZINC PLATED
PACKED: 5 CDS/BX - 60/CASE
WEIGHT: 4 LBS/BOX
LIST PRICE: 6.38 Ea.

CD-577Z DOUBLE FLEXIBLE LINK SAFETY HASP



SIZE: 7¾", ZINC PLATED
PACKED: 5 CDS/BX - 60/CASE
WEIGHT: 4½ LBS/BOX
LIST PRICE: 7.25 Ea.

**TA-555GV-PWS SAFETY HASP
WITH LOCKING SWIVEL KEEPER**

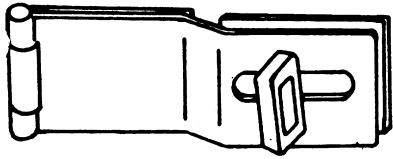

DESCRIPTION: Designed to lock hasp by a swivel type keeper:
Locks merely by turning swivel keeper. Polybagged with screws.

FINISH: Steel - Zinc Plated	Size	Wt./Doz.	List/Doz.	List/Ea.
PACKING: 1 Dz. Per Box	3½"	3.3 lbs.	\$8.34	1.75
50 Dz. Per Ctn.	4½"	4.3 lbs.	9.18	1.93

**CD-940 HEAVY DUTY
SAFETY HASP LOCK**

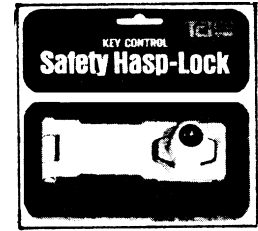

DESCRIPTION: Heavy duty
cam action lock with key lock.
Cannot be opened without key,
even when glass is broken.

FINISH: Baked Aluminum- Rust Resistant	Size	Wt/Ctn.	List/Ea.
PACKING: 12 Cds/Box – 120/Case	2½"	3.42 lbs.	\$5.63/cd
	3"	3.50 lbs.	5.75
	4"	6.75 lbs.	6.70
	4½"	7.00 lbs.	7.08

**CORNER BRACES, FLAT-CORNER IRONS, MENDING PLATES, TEE PLATES
HEAVIER THAN ALL OTHER LEADING BRANDS**

HEAVIEST GAUGE TYPE	Item No./ Description	Size (inches)	Thickness (inches)	Weight (lbs) per 144 pc.	Packed per case (dz. pcs.)	List Price	List Price	List Price	List Price
						PS	GV	PS	GV
						PER DOZEN PCS.		PER 100 PCS.	
	TA-995PS	2 x 5/8	.109"	4 lbs.	50 dz.	\$2.58	\$3.03	\$21.43	\$25.15
	TA-995GV	2½ x 5/8	.109"	5	50	2.95	3.50	24.50	29.13
		3 x 3/4	.109"	7	50	3.65	4.23	30.95	35.20
	MENDING PLATES	3½ x 3/4	.109"	9	30	4.33	5.13	35.88	42.65
	Similar to Stanley #995	4 x 7/8	.109"	12	26	4.98	6.08	41.35	50.53
	Packed 2 dozen per box	5 x 1	.109"	16	18	7.00	8.15	58.43	61.80
	without screws, prices	6 x 1½	.109"	25	12	8.95	10.88	74.63	90.55
	per dozen	8 x 1½	.109"	34	12	17.18	19.95	112.63	166.28
	TA-995½PS	2½ x 1½	.062"	8	60	\$12.23	\$12.68	\$102.38	\$105.40
	TA-995½GV	3 x 5/8	.062"	11	50	15.55	16.13	129.53	134.28
	TEE PLATES	4 x 3/4	.078"	21	30	18.28	19.75	152.25	164.45
	Similar to Stanley #995½	5 x 7/8	.078"	39	18	25.60	30.53	213.30	254.23
	Packed 2 dozen per box	6 x 7/8	.078"	46	12	31.98	44.20	266.35	368.18
	without screws, prices								
	TA-997PS	1 x 1½	.109"	3	120	\$2.05	\$2.43	\$16.93	\$20.13
	TA-997GV	1½ x 1½	.109"	5	120	2.65	3.05	22.13	25.38
		2 x 5/8	.109"	9	84	3.43	4.43	28.45	36.73
		2½ x 5/8	.109"	13	48	4.70	5.85	39.38	48.55
		3 x 3/4	.109"	19	36	6.90	8.58	57.35	71.30
	CORNER BRACES	3½ x 3/4	.109"	26	24	9.08	11.30	75.48	94.05
	Similar to Stanley #997	4 x 7/8	.156"	35	18	17.20	20.68	143.28	172.10
	Packed 2 dozen per box	5 x 1	.187"	63	12	22.18	29.53	184.58	245.80
	without screws, prices	6 x 1	.187"	84	12	29.10	37.10	242.40	308.98
	per dozen	8 x 1½	.187"	119	10	43.33	56.48	360.95	470.35
	TA-999PS	1½ x 3/8	.062"	3	120	\$2.40	\$2.58	\$19.90	\$21.43
	TA-999GV	2 x 3/8	.062"	4	120	2.45	2.88	20.35	48.85
		2½ x 1/2	.062"	6	84	3.35	3.85	27.83	31.93
		3 x 5/8	.062"	9	48	4.08	4.65	34.13	38.70
	FLAT CORNER IRONS	3½ x 5/8	.062"	10	36	5.53	6.83	45.95	56.90
	Similar to Stanley #999	4 x 3/4	.078"	18	36	7.03	7.55	58.43	62.80
	Packed 2 dozen per box	5 x 7/8	.078"	24	24	12.00	13.98	100.03	116.35
	without screws, prices	6 x 7/8	.078"	31	12	12.88	17.33	107.18	144.38
	per dozen	8 x 1½	.078"	66	12	27.68	38.85	230.48	323.75

**USA HEAVY GAUGE TYPE - USA SPECIFICATIONS
BRASS PLATED & NICKEL PLATED
STEEL CONTINUOUS HINGES WITH STEEL PINS**

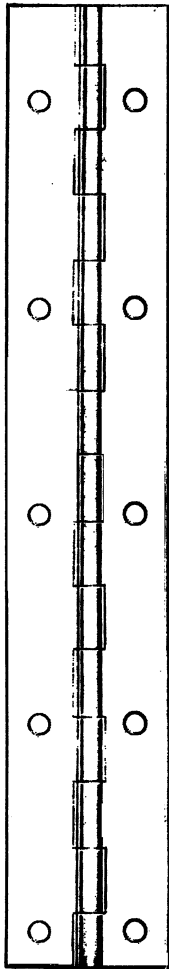

DESCRIPTION	ITEM NO. & FINISH	LENGTH	WIDTH OPEN	GAUGE	LENGTH PER CASE	LBS. PER CASE	LIST PRICE PER LENGTH		
Nickel Plated Steel Pin With Holes TA1311	TA1311NP-SP (Similar to Stanley 311)	6'	1 1/16"	.040	100	131	\$10.13		
		6'	1 1/4"	.040	100	148	10.93		
		6'	1 1/2"	.040	100	168	11.70		
		6'	2"	.045	50	125	15.75		
		6'	2 1/2"	.060	50	N/A	26.25		
		6'	3"	.060	50	N/A	32.23		
		7'	1 1/2"	.040	100	193	13.73		
		7'	2"	.045	50	144	18.35		
		7'	2 1/2"	.060	50	N/A	32.03		
		7'	3"	.060	50	N/A	36.80		
		8'	1 1/2"	.040	100	223	15.75		
		8'	2"	.045	50	166	20.95		
		8'	2 1/2"	.060	50	N/A	46.10		
		8'	3"	.060	50	N/A	49.15		
		Brass Plated Steel Pin With Holes TA1311	TA1311BP-SP (Similar to Stanley 311)	6'	1 1/16"	.040	100	131	9.70
				6'	1 1/4"	.040	100	148	10.70
6'	1 1/2"			.040	100	168	11.55		
6'	2"			.045	50	125	15.18		
6'	2 1/2"			.060	50	N/A	25.45		
6'	3"			.060	50	N/A	30.13		
7'	1 1/2"			.040	100	193	13.43		
7'	2"			.045	50	144	17.65		
7'	2 1/2"			.060	50	N/A	31.53		
7'	3"			.060	50	N/A	34.25		
8'	1 1/2"			.040	100	223	16.13		
8'	2"			.045	50	166	20.08		
8'	2 1/2"			.060	50	N/A	42.13		
8'	3"			.060	50	N/A	46.80		
BRASS PLATED STEEL CONTINUOUS HINGES WITH SOLID BRASS PINS									
NICKEL PLATED									
DESCRIPTION	TACO NO. & FINISH	LENGTH	WIDTH OPEN	GAUGE	LENGTH PER CASE	LBS. PER CASE	LIST PRICE PER LENGTH		
TA1311 Brass on steel with Brass Pin, Cold Rolled Steel Screw Holes 2" apart, 1/2" joints	TA1311BP-BP (Similar to Stanley 311)	6'	1 1/16"	.040	100	131	\$11.65		
		6'	1 1/4"	.040	100	148	12.20		
		6'	1 1/2"	.040	100	168	12.78		
		6'	2"	.045	50	125	16.33		
		6'	2 1/2"	.060	30	120	54.43		
		6'	3"	.062	20	125	58.48		
		7'	2 1/2"	.060	30	150	62.95		
		7'	3"	.062	20	145	67.58		
		8'	2 1/2"	.060	20	150	71.63		
		8'	3"	.062	20	155	77.70		
TA1311 Nickel on Steel Brass Pin	TA1311NP-BP	6'	1 1/16"	.040	100	131	\$12.08		
		6'	1 1/4"	.040	100	148	12.50		
		6'	1 1/2"	.040	100	168	12.98		
		6'	2"	.045	50	125	16.75		
		6'	2 1/2"	.060	30	120	56.30		
		6'	3"	.062	20	125	59.38		
		7'	2 1/2"	.060	30	150	65.70		
		7'	3"	.062	20	145	70.33		
		8'	2 1/2"	.060	20	150	74.38		
		8'	3"	.062	20	155	80.45		

STEEL CONTINUOUS HINGES WITH STEEL PIN

DESCRIPTION	ITEM NO. & FINISH	LENGTH	WIDTH OPEN	GAUGE	LENGTH PER CASE	LBS. PER CASE	PRICE/LENGTH With or Without Holes
TA1311 Plain Steel Continuous Hinges, with or without Holes	TA1311PS-SP With or Without Holes (Similar to Stanley 311)	6'	1 1/16"	.040	100	131	\$7.08
		6'	1 1/4"	.040	100	148	7.50
		6'	1 1/2"	.040	100	168	8.53
		6'	2"	.045	50	125	10.55

CONTINUOUS HINGES & HATCH TRIM

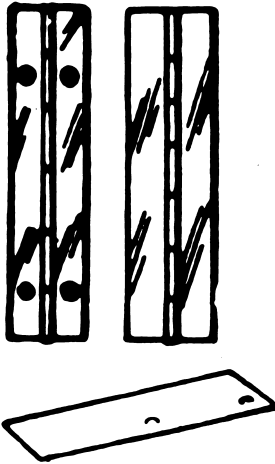

SOLID BRASS CONTINUOUS HINGES SOLID BRASS PIN

Item No./Description	Finish	Length	Width open	Gauge	Length per case	Lbs./case	Price per length	
TA-SB1311 1/4 Solid Brass Continuous Hinges with solid brass pin, screw holes 2" apart, 1/2 knuckle joints. (Similar Stanley 311 1/4)	TA-SB1311 1/4 PB	6'	1 1/16"	.040	100	131	\$61.58	
	Polished Brass & Laquered	6'	1 1/4"	.040	100	148	66.33	
		6'	1 1/2"	.040	100	168	72.78	
	2"	6'	2"	.045	50	125	116.25	
		7'	2 1/2"	.060	30	158	213.55	
		7'	3"	.062	30	166	235.35	
	TA-SB1311 1/4 CMP	Polished Chrome & Laquered	6'	1 1/16"	.040	100	131	76.50
			6'	1 1/4"	.040	100	148	80.10
			6'	1 1/2"	.040	100	168	85.80
			6'	2"	.045	50	125	120.38
2 1/2" x 7'			7'	2 1/2"	.060	30	158	244.03
3" x 7'			7'	3"	.062	30	166	258.45

SOLID ALUMINUM CONTINUOUS HINGES WITH ALUMINUM PINS

Item No./Description	Finish	Length	Width open	Gauge	Length per case	Lbs./case	Price per length
TA-AL1311 † Aluminum Continuous Hinges with or without holes (please specify) 1/2" knuckle joints	TA-AL1311	6'	1 1/16"	.040	100	90	\$13.13
		6'	1 1/4"	.040	100	110	13.73
		6'	1 1/2"	.045	100	130	39.50
		6'	2"	.045	100	150	20.20
		6'	2 1/2"	.060	50	90	30.80
		6'	3"	.062	50	110	37.80

SOLID STAINLESS STEEL CONTINUOUS HINGES STAINLESS STEEL PINS - U.S.A. SPEC.

Item No./Description	Finish	Length	Width open	Gauge	Length per case	Lbs./case	Price per length
TASS1311 18.8 Non-corrosive, Non-magnetic Continuous Hinges with holes	TASS1311US32D Satin Finish (Similar Stanley SS311)	6'	1 1/16"	.040	100	131	\$19.95
		6'	1 1/4"	.040	100	148	21.88
		6'	1 1/2"	.040	100	168	25.03
		6'	2"	.045	50	125	29.98

STATUARY BRONZE CONTINUOUS HINGES WITH STEEL PIN - U.S.A. SPEC.

Item No./Description	Finish	Length	Width open	Gauge	Length per case	Lbs./case	Price per length
TA1311 Statuary Bronze Steel pin with holes	TA1311ST-BZ-SP (Similar Stanley 311)	6'	1 1/16"	.040	100	131	\$10.85
		6'	1 1/4"	.040	100	148	11.70
		6'	1 1/2"	.040	100	168	12.45
		6'	2"	.045	50	125	16.90

HATCH TRIM (EXTRUDED SOLID BRASS)

Item No./Description	Finish	Length	Width open	Gauge	Length per case	Lbs./case	Price per length
TA-SB1350 Solid Brass Hatch Trim	TA-SB1350 Polished Chrome	6'	1 1/4"	.040	100	148	\$12.30
		6'	1 1/2"	.040	100	168	13.55

CLOSEOUT AT 1/2 OF CURRENT MARKET VALUE!

PRICES AVAILABLE FOR SCREWS UPON REQUEST!

All continuous hinges sold only in multiples of 10 lengths, same size & finish.

1) Continuous hinges also available in other lengths, finishes, metals. Write for prices and samples.

†2) Plain Steel and Aluminum available blank without holes drilled, or drilled and countersunk

PLEASE BE SURE TO SPECIFY TYPE WANTED.

HEAVY GAUGE PATTERN SHELF BRACKETS

Heavier than most other lightweight brackets being marketed, such as Stanley 797 Series.

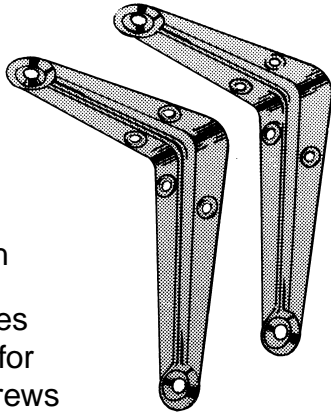

Heavy, deep fluting adds extra strength

All screw holes countersunk for large size screws

NOW AVAILABLE IN 3 ACRYLIC LACQUERED FINISHES

WH - WHITE
BN - BROWN
GE - GREY

These finished brackets need no painting

- 60% heavier than most other lightweight brackets now being marketed such as Stanley #797 Series.
- Acrylic lacquered after fully manufactured, not like many other brands which are manufactured from prepainted sheet steel which result in all unfinished edges and screw holes.
- All screw holes are with fully finished countersinking for use with large size flat countersunk head screws while most USA competitors' brackets are with small non-countersunk screw holes which require round head screws which don't have as much holding power as heavy flathead countersunk screws.

Cross Reference

Lawrence No. 292
Stanley old Series No. 796
National heavy Series No. 110

DESCRIPTION	SIZE	LBS./DZ. PR.	DOZEN PAIR PER MASTER CARTON	LIST PRICE PER DZ. PAIR	LIST PRICE EACH BRACKET
TA-1100 SERIES Heavy Shelf Brackets (Similar to Stanley old No. 796) Heavy pattern with countersunk holes. Baked Grey Enameled	3" x 4"	2.5	12 dz./pr.	\$8.53	.36
	4" x 5"	3.3	12 dz./pr.	10.10	.42
	5" x 6"	4.5	12 dz./pr.	13.40	.56
	6" x 8"	8.0	6 dz./pr.	15.95	.66
	8" x 10"	11.5	6 dz./pr.	24.55	1.02
	10" x 12"	14.2	3 dz./pr.	32.45	1.35
	12" x 14"	18.0	3 dz./pr.	40.33	.67

FOLDING SHELF BRACKETS

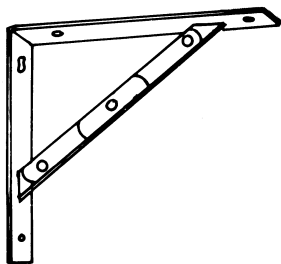

DESCRIPTION	SIZE	LBS./DZ. PR.	DOZEN PAIR PER MASTER CARTON	LIST PRICE PER PAIR
TA-1150WT Shelf Brackets Folding Type (Similar to Stanley No. 794) without screws White enameled	8 x 8	12.0	8 dz./pr.	\$8.93
	12 x 12	24.0	4 dz./pr.	13.00
	16 x 16	40.0	4 dz./pr.	17.08

ORNAMENTAL DOOR & GATE HINGES

EX-HH10BK – 10"

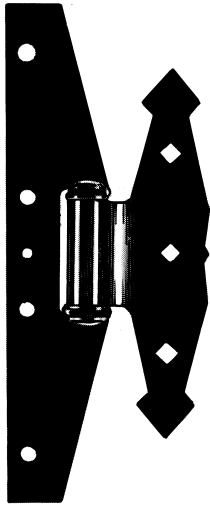

*The ultimate hinge for use with
Ornamental, Commercial, Rural and
Residential Doors or Gates*

Description:
Non-handed-reversible.
Button tip, tight pin.
Baked, durable black
lacquered finish.

Packed:
40 Per Master Carton

LIST PRICE:
\$7.75 Ea.

ORNAMENTAL DOOR & GATE HINGES

TA-HH7BK – 7"

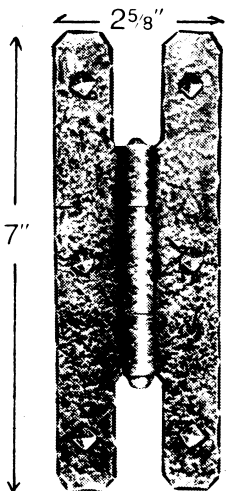

Description:
7" Hammered wrought steel H-Hinge with solid brass
washer bearing. Gauge 0.125 in. (1/8")
Popular for use on exterior ornamental iron doors.

Finishes:
BK-Baked Black Enamel
BR-Brown
WH-White

Weight:
8 1/4 Lbs./Box of 5 Pair

Available with 3/16" or 1/4"
holes. Please specify
when ordering.

Packed:
10 Each Box
100 Each/Case

LIST PRICE:
\$3.68 Ea.